

Combined Motor Start and Braking Device
VBMS ...
Assembly- and Commissioning Instructions

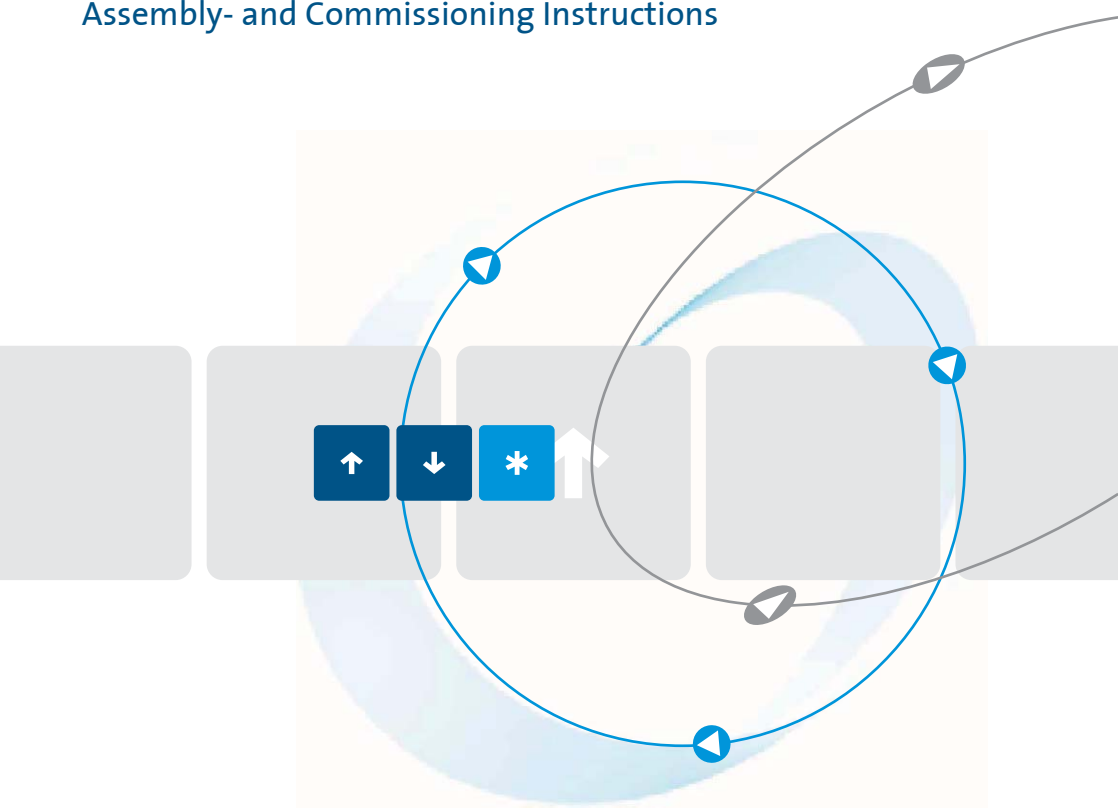

as per 04/10

1C000.10001

Table of Contents	Page
1. Safety notes	3
2. Conformity	3
3. General description	4
4. Usage to the intended purpose	4
5. EC Declaration of Conformity	5
6. Block diagram	6
7. Functional description	7
8. LED indicators	8
9. Control inputs	9
10. Potentiometers	9
11. Technical data	10
11.1 Environmental conditions	10
12. Commissioning	11
12.1 Mounting instructions	11
12.2 Connection	11
12.3 Parameter settings	12
12.4 Possible fault indications during commissioning	13
13. Dimensioning rules	14
13.1 Dimensioning of braking device	14
13.2 Dimensioning of pre-fuses	15
13.3 Permissible braking frequency	17
14. Dimensional drawings	18
15. Typical connections	19
15.1 Connection diagram	19

These commissioning instructions were prepared with great care. Nevertheless, PETER electronic GmbH & Co. KG does not assume liability for damage resulting from mistakes possibly contained in this manual. Technical changes that serve to improve the product are subject to change without notice.

Notes and symbols used in these instructions

Note: Notes explain the advantages of certain adjustments or settings and help you to make use of the device in the best possible way.



Warning notices: Read them carefully and follow them strictly!

Warning notices are indicated in order to protect you against danger or to help you to prevent the device from being damaged.



Caution: Danger to life through electric shock!

When you see this sign, always make sure that the device is de-energized and secured against unintentional energizing.

1. Safety notes



The described devices are electrical equipment for use in industrial electrical power installations. An impermissible removal of the covers during operation can cause serious damage to your health, since these devices contain live parts with high voltages.

Adjustment work may only be performed by trained staff observing the safety regulations. Assembly and mounting work may only be carried out with the equipment deenergized.

Make sure that all drive components are properly earthed.

Please read these commissioning instructions carefully before putting the device into operation.

Besides, the user must ensure that the devices and associated components are fitted and connected in accordance with the applicable local, legal and technical regulations. The VDE-regulations VDE 0100, VDE 0110 (EN 60664), VDE 0160 (EN 50178) , VDE 0113 (EN 60204, EN 61310), VDE 0660 (EN 50274) plus the appropriate regulations of the TÜV (Technical Control Association) and the trade associations apply in Germany.

The user must ensure that the drive turns into a safe operating state following a device failure, in the event of maloperation, or if the control unit has failed etc..

Caution: Even if the motor is at rest, it is **not** physically separated from the mains.

2. Conformity

In industrial linguistic usage the electronic brakes with motor contactor of the type series VBMS... are called "devices", however, in the sense of the "device-safety-law", the "EMC-law" or the "EC machinery directive" they are not devices or machines ready for use or connection but they are components. It is only possible to define their final function, when these components are integrated into the design and construction of the user.

To be able to use the devices to their intended purpose, it requires power supply networks according to DIN EN 50160 (IEC38).

The user takes the responsibility that the user's design and construction comply with the applicable legal provision.

The commissioning is strictly forbidden as long as the conformity of the final product with the guidelines 2006/42/EC (Machinery directive) and 2006/95/EC (Low voltage directive) is not proved.

3. General description

The type VBMS ... is a compact motor control unit which includes both a motor contactor with a contact gap $\geq 3\text{mm}$ and an electronic braking device.

Because of the integrated motor contactor it is with a modest amount of wiring work possible to implement the functions „Motor On“ and „Motor Braking“.

The braking current is controlled and can be adjusted within a range of 10-100% of the rated device current. An integrated standstill detection function switches the braking current off after the motor has come to a standstill. The control inputs are metallically separated from the load (24V extra-low voltage).

Various fault conditions are indicated via LED „on“ .

Special features:

- simple motor control with only a few elements
- motor contactor and DC-brake in a single device
- suitable for all asynchronous motors
- controlled bei microcontroller
- easy mounting, also for retrofitting into existing plants
- motor contactor with contact gap $\geq 3\text{mm}$, utilization category AC-3
- operator's controls physically separated from load (24V extra-low voltage)
- connection of several „OFF“-buttons possible (e.g., motor temperature switch)
- for snap-on mounting on 35mm DIN rail
- degree of protection IP 20
- meets trade assoc. requirements for category 2 acc. to EN 954-1 according to the test principles of GS-HO-01
- intermateable with BRMS

4. Usage to the intended purpose

The devices of the VBMS series are electrical equipment that is used in industrial power installations. They are designed for an application in machines, in order to switch on and to decelerate drives with three-phase a.c. motors.

Typical applications:

- sawing machines
 - centrifuges
 - vibrators
-

5. EC Declaration of Conformity

EC Declaration of Conformity 

The manufacturer / company placing the product on the market
(authorized representatives of the manufacturer / companies placing the product on the market
that are established within the Community)

Name / Address: Peter Electronic GmbH & Co.KG
Bruckäcker 9
92348 Berg
Germany

hereby declares that the following product (device, component, unit) in the version as supplied

Product designation: **Combined Motor Start and Braking Device**
Serien / type designation: VBMS 230-1,5/20; VBMS 400-2,2/20
Article group: 2C0...
Year of manufacture: 2007

complies with the provisions of the following EC-directives:

2004/108/EG concerning Electromagnetic compatibility and **2006/95/EG** concerning Electrical equipment designed for use within certain voltage limits

The following harmonized standards have been applied:

EN 60947-1: 2008	Low-voltage switchgear and controlgear General rules	EN 60947-4-2: 2007	Low-voltage switchgear and controlgear Contactors and motor-starters - AC semiconductor motor controllers and starters
------------------	---	--------------------	---

This EC Declaration of Conformity is no longer valid, if the products is modified or changed
without our agreement.

This declaration is issued under the sole responsibility of the signatory.

Berg, 05.08.2009
(place, date)

Dr. Thomas Stiller, Managing Director
(signatory and function of the signatory)

(signature)

6. Block diagram

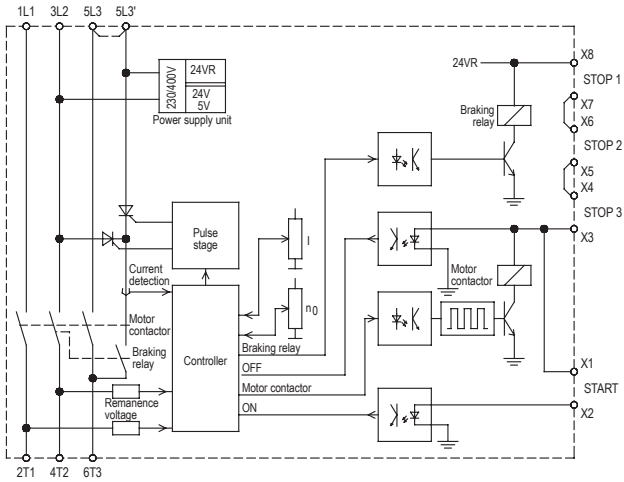

7. Functional description

The terminals for the „ON“ or „OFF“-buttons are connected to a 24V extra-low voltage that is physically separated from the mains potential.

When actuating the „ON“-button connected with the terminals X1-X2, the integrated motor contactor switches the motor on.

If one of the contacts on the terminals X3-X4, X5-X6 or X7-X8 is opened, the integrated motor contactor switches off and initiates braking. During braking, the integrated motor contactor is interlocked against switching-on. After a delay time which, dependent on the amount of the remanent voltage of the motor, optimizes itself, the integrated braking relay pulls in. After the contact bounce time has been waited out, a controlled d.c. current is fed into the motor winding. The magnetic field resulting from this has a braking effect on the still rotating rotor. The d.c. current is generated by a thyristor phase control. Special suppressor circuits protect the power semiconductors against overvoltage.

With the potentiometer I, the braking current (and thus the braking torque) can be adjusted within a range of 10 ... 100% of the rated device current. The integrated motor standstill detection, which functions via the amount of the remanent voltage, switches the braking current off approx. 1,5s after a motor standstill has been detected. To be able to adapt the device to a variety of motors, it is possible to adjust the standstill threshold via the potentiometer n0).

Faults that occur during operation of the device are indicated via the „ON“ LED.

A motor protecting switch may additionally be wired in series before VBMS... device.

For this purpose, the wire jumper between 5L3 and 5L3' has to be removed. The wiring is then to be effected as illustrated in the connection diagram.



Warning notices:

To ensure a reliable standstill detection function, it is necessary to comply with the following: The braking current must not exceed (3) three times the amount of the rated motor current. If the VB-L is operated without the 6T3 (T3)-terminal being connected, which always applies in the case of single-phase applications, it is to be ensured that braking current flows at least for a period of 1.5 s before the motor comes to a standstill, as no motor standstill is detected within this period of 1.5s and the braking current would then flow over the total maximum braking time. This could cause destruction of the motor and fault indications of the braking device.

Note: If the braking time at rated device current is too short, due to the fact that the centrifugal masses to be slowed down are too large, either a device with a longer braking time can be inquired of the producer or a device featuring a higher rated current has to be used.

8. LED indicators

LED - on	Operational status	Fault correction
Illuminated	Motor runs	
Flashing 1x repeatedly with a short pause	no motor stillstand detected	Fault will be reset by motor restart (voltage on T1, T2, T3). Fault can only be reset by disconnecting the device for 5s from the mains voltage (motor contactor is interlocked).
Flashing 2x repeatedly with a short pause	Adjusted braking current was not reached	
Flashing 3x repeatedly with a short pause	Braking frequency too high	
Flashing 4x repeatedly with a short pause	Contacts of the motor contactor are charred/short-circuited.	
Flashing 5x repeatedly with a short pause	3x in succession no motor stillstand detected	
Flashing 6x repeatedly with a short pause	Program error	

LED - braking	Operational status
Illuminated	Braking current is flowing

9. Control inputs

Control terminals	Designation	Description
X1, X2	Starting contact	Connection of an „ON“-button (normally open contact)
X3, X4; X5, X6; X7,X8	Braking contact	Connection of an „OFF“-button (normally closed contact)

10. Potentiometers

With the potentiometers it is possible to adjust the following parameters.

„I“

Adjusting the braking current:

The braking current can be adjusted in the range from approx. 10% - 100% of the rated device current. The adjustment is roughly linear.

„t“

Adapting the standstill threshold and braking behavior at motor standstill.

With this potentiometer it is possible to adapt the motor standstill threshold to various motor types and applications and to influence the behavior of the braking current at motor standstill.

In „left stop“ (full counter-clockwise) position, the standstill detection function is most sensitive, and the braking behavior, upon reaching the motor standstill, is most soft. Possibly, the braking current is switched off even before the motor has come to a standstill. The potentiometer has to be adjusted so that the braking current is switched off approx. 1-1.5s after the motor has come to a standstill.

Factory-setting: approx. 40%.

Note!

If the potentiometer is adjusted to a position too far in clockwise or counter-clockwise direction (e.g., end stop position), it may happen that no standstills are detected. In this case, braking current flows until the end of the max. braking time. The LED indicates „no standstill during the max. braking time“.

11. Technical data

Type designation VBMS	400-2,2/20	230-1,5/20
Rated operational voltage 50/60Hz according to DIN EN 50160 (IEC 38)	3x 380/415V ±10%	3x 200/240V ±10%
AC-3 Rated operational power	2,2kW	1,5kW
Conventional Thermal current $I_{th} = I_e$	16A	
Braking current	2...20A	
max. braking time	10s	
max. braking frequency at braking current 10A braking current 20A	at 5s braking time: 1 in 25s at 10s braking time: 1 in 50s at 5s braking time: 1 in 60s at 10s braking time: 1 in 120s	
Delay time during switch-off and braking	500ms	
Braking voltage	0...220V DC	0...110V DC
max. Cross-sectional area	2,5mm ² per terminal	
Weight	0,6kg	

11.1 Environmental conditions

Storage temperature	-25 ... 75°C
Operating temperature	0 ... 45°C
Degree of protection	IP 20
Environment	Overvoltage category III, pollution degree 2

12. Commissioning

The device is to be put into operation in 3 steps:

1. Mounting
2. Connection and
3. Parameter setting

12.1 Mounting instructions



Caution: Danger to life through electric shock!

The following conditions are to be complied with in order to ensure a safe and reliable operation of the VersiBrake...-L (LP).

1. The device series VersiBrake...-L (LP) is to be used under overvoltage conditions of the category III.
2. Make sure that pollution degree 2 or better, in accordance with IEC664, is complied with.
3. The device is to be installed into a housing (min. degree of protection: IP54).
4. The device must be operated without being exposed to contamination by water, oil, carbon deposits, dust, etc..



Warning:

Make sure that a minimum distance to adjoining devices is kept. Above and underneath the housing a minimum distance of 50mm is to be kept.

12.2 Connection

The braking device (with integrated motor contactor) is to be installed according to the attached connection diagram. For other connections please consult PETER electronic GmbH & Co. KG.

Note: Further connection proposals for special circuit arrangements are available via our homepage at www.peter-electronic.com.

Note: Prior to putting the motor brake into operation the wiring is to be checked.



Warning:

In the case of high-inertia starting, it may happen that the fuses blow.

12.3 Parameter settings

Sequence of steps during commissioning:

(the designations/details indicated in brackets refer to the circuit-board version)

1. Disconnect the plant/system from the supply mains.
2. Adjust the requested braking current with the potentiometer „I“, „(P2)“.
Since the potentiometer reacts roughly linear, it is possible to infer the braking current from the potentiometer setting.
Left stop (counter-clockwise direction) roughly equals 10% of the rated device current.
Mid-position roughly equals 50% of the rated device current.
Right stop (clockwise direction) equals 100% of the rated device current.
3. Adjust potentiometer „n0“, „(P1)“ to approx. 40%.
4. Switch on the plant.
5. Initiate braking by switching the motor ON/OFF.

Note: When putting the device into operation for the first time, the braking current can be checked with a true r.m.s. measuring instrument.

Adjusting the braking current

The braking current is to be adjusted to a value as small as possible, in order to avoid unnecessary heating of the power semiconductors and motor. This is especially important in the case of high switching frequencies. We recommend to limit the max. braking current to 2.5 times the rated motor current.

The requested braking torque can be adjusted with the potentiometer „I“, „(P2)“.

Adjusting the braking time

No adjustments are required, since the braking current is automatically switched off approx. 1.5s after a motor standstill has been detected.

If no standstill is detected during the max. braking time (10s in the case of standard devices), the braking current is switched off when this time is over. This case is indicated by the LED „ready“, „(V9)“ (flashing 1x).

Adjusting the standstill threshold

In most applications, the factory-setting (40%) produces good results.

If the braking current is switched off before the motor has come to a rest, or if the braking current is not switched off approx. 1.5s after the motor has come to a rest, it is possible to make an adjustment with this potentiometer. The optimum setting has to be found by carrying out several braking operations. The potentiometer should be changed only in little steps (10%). For a more detailed functional description please refer to page 9.

12.4 Possible fault indications during commissioning

During commissioning, and in normal operation too, fault indications can occur. The following explanation is to give you assistance in the localization and correction of faults.

Fault indication on LED „Ready“, „(V9)“	Fault	Possible cause	Fault correction
Flashing 1x	No motor standstill during max. braking time	Braking current adjusted to a too small value.	Adjust braking current to a higher value.
		Too large centrifugal mass.	Use VBMS with longer max. braking time.
		Terminal „6T3“ „(T3)“ is not connected and the motor is not supplied with current for a period of 1,5s prior to the standstill.	If possible, connect 6T3 (T3) or adjust the braking current to a slightly lower value.
		Standstill threshold is not adapted.	Adapt standstill threshold with „n0“.
Flashing 2x	Adjusted braking current was not reached.	Interruption in the braking circuit. Possibly the motor is started with star-delta connection.	Check circuit. Possibly the star contactor has to be closed during braking.
		The resistance of the motor winding is too high for the adjusted braking current.	Turn braking current back so that the fault does not occur any more.
Flashing 3x	VBMS is overloaded. Braking frequency is too high.	The specified max. braking frequency is exceeded.	Reduce braking current or braking frequency. During commissioning, 4 braking operations in succession can be initiated without an overload being indicated.
Flashing 4x	Contacts of motor contactor are charred/short-circuited.	Starting current of the motor is too high (high-inertia starting, blocked motor).	Send device for repair.
		Motor with too high power rating was connected.	Send device for repair.
Flashing 5x	3x in succession no standstill detected	Braking current adjusted to a too small value.	Adjust braking current to higher value.
		Centrifugal mass is too large.	Use braking device with longer max. braking time or higher rated device current.
		Standstill threshold is not adapted.	Adapt standstill threshold with „n0“.
Flashing 6x	Program error	Program crash	Send device for repair.

13. Dimensioning rules

Note! All data sheets and commissioning instructions are available on our homepage at www.peter-electronic.com.

13.1 Dimensioning of braking device

For most applications, it is relatively easy to select a suitable braking device.

In most cases, an acceptable braking torque is achieved, if, during braking, the motor is connected in **Y** (star) and the braking current is 2 times as high as the rated motor current. If, during braking, the motor winding can only be connected in **Δ** (delta), the braking current has to be at least 2.5 times as high as the rated motor current in order to achieve a sufficiently high braking torque.

If special applications require more precise calculations, the following formula can be used.

Calculating the braking current (I_B)

$$I_B = f_B \cdot \sqrt{\frac{t_A}{t_B}} \cdot I_N$$

I_B = Braking current in A

f_B = Braking factor acc. to table 1

t_B = Braking time required (in s)

I_N = Nominal/rated motor current (in A)

t_A = Time until nominal speed is reached
(in the case of motors with star-delta start - approx. switch-over time)

Values usual for t_A :

Conveyor belt: 20s, Pump: 8s, Power crusher: 30s,
Compressor: 10s, Fan: 20s, Circular saw: 10s



Connection of motor winding	
at nominal operation	during braking
	 $f_B = 3$
	 $f_B = 2.6$  $f_B = 1.7$

Table 1

Calculating the cyclic duration factor (ED):

$$ED = \frac{t_B}{t_Z} \cdot 100$$

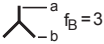
 t_B = Braking time t_Z = Cycle time (Running-Braking)

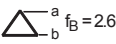
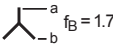
If the required cyclic duration factor (c.d.f.) exceeds the permissible values indicated on the data sheet, the permissible maximum braking current is to be accordingly reduced. The data required in this connection can be found in the device-specific commissioning instructions.

If it is not possible to reduce the braking current, a braking device with a higher braking current has to be used.

Example: If the required c.d.f. is twice as high as the value indicated on the data sheet, a braking device of twice the nominal/rated device current has to be used.

13.2 Dimensioning of pre-fuses

Basically, two types of fuse protection are available for the user:

1. Fusing according to allocation type „1“, DIN EN 60947-4-2.
After a short circuit, the braking device is allowed to be inoperative.
2. Fusing according to allocation type „2“, DIN EN 60947-4-2.
After a short circuit, the braking device must be suitable for further use. However, there is the danger that the contacts of the braking relay (braking contactor) weld. Therefore, if possible, these contacts are to be checked prior to applying again mains voltage to the device. If this check cannot be carried out by the user, the device has to be returned to the producer in order to have it checked.

The following dimensioning information refers to the below operating conditions:

- Use of standard asynchronous motors
 - Braking time not exceeding 20s, for braking devices up to 36A
 - Braking time not exceeding 40s, for braking devices from 40A up
 - Braking current not exceeding $2.5 \times I_{NOM}$ of the motor.
 - Cyclic duration factor (c.d.f.) not exceeding the value indicated in the data sheet.
-

Fusing according to allocation type „1“:

As pre-fuses, we recommend to use line protection fuses (utilization category gL) or automatic circuit breakers with tripping characteristic B, C, D or K.

Taking into account the maximum braking currents that occur (normally the rated device current), we recommend fuses according to table 2, column 3.

Note: Wiring cross-sectional area according to DIN VDE 0100-430,
DIN EN 57100-430.

Fusing according to allocation type „2“:

The power semiconductors are to be protected by fuses of the utilization category gR (semiconductor fuses, high-speed fuses). However, since these fuses do not ensure line protection, it is necessary to use additionally line protection fuses (utilization category gL).

As for the dimensioning of the line protection fuse (gL), please refer to table 2, column 3.

To protect the semiconductors it is necessary to select gR-fuses featuring cutoff- I^2t -values of the ranges indicated in table 2, column 4. In this connection, the fuse rating of the selected fuse should not be smaller than the braking current to be expected (rated device current).

Note 1: On the basis of the recommended I^2t -value, braking current, and possibly the c.d.f., the fuse supplier is able to select a suitable type. Due to the great variety of producers, sizes, and types, PETER electronic does not recommend any particular fuses.

Note 2: If the fuse or cutoff- I^2t -value is selected too small, it may happen that the semiconductor fuse reacts during braking.

Column 1	Column 2	Column 3	Column 4
max. Braking current / Rated device current	Device type	Fuse value in the case of allocation type 1	Recommended range for cutoff- I^2t -value of semiconductor protection fuses in the case of allocation type „2“
20A	VBMS	16A	300... 650 A ² s

Table 2

13.3 Permissible braking frequency

The braking frequency depends on the adjusted braking current:

Braking current	Braking time	Braking frequency
20A	5s 10s	1 Braking per 63s 1 Braking per 125s
15A	5s 10s	1 Braking per 34s 1 Braking per 67s
10A	5s 10s	1 Braking per 22s 1 Braking per 44s



Warning:

When setting up a machine or during commissioning, it is possible to carry out 5 braking operations in succession, i.e., with rated device current and at a braking time of 10s. After such operating conditions, however, the device needs a recovery time of 15 minutes.

Load curve for VBMS

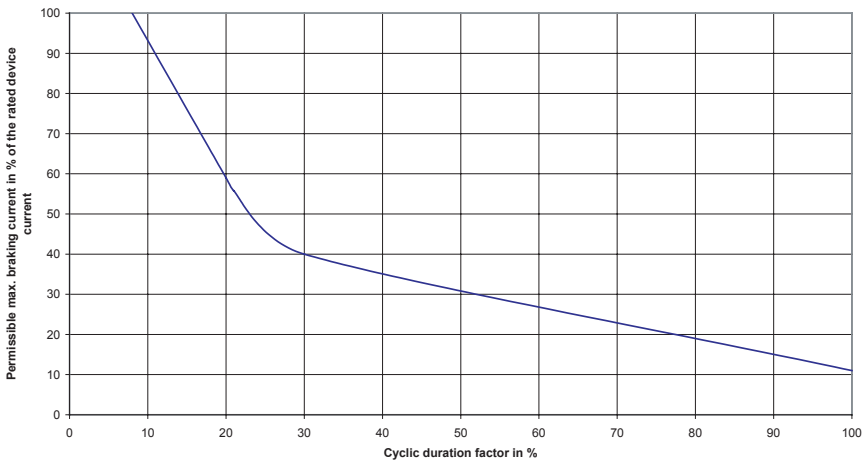

cyclicduration factor (r.c.d.f.) = $t_B / \text{cycletime} \times 100$

t_B = Braking time, Cycle time = Braking time + Non-braking time

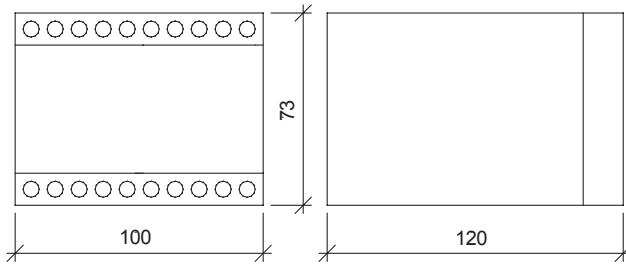
14. Dimensional drawings

All dimensions in mm.

15. Typical connections

15.1 Connection diagram

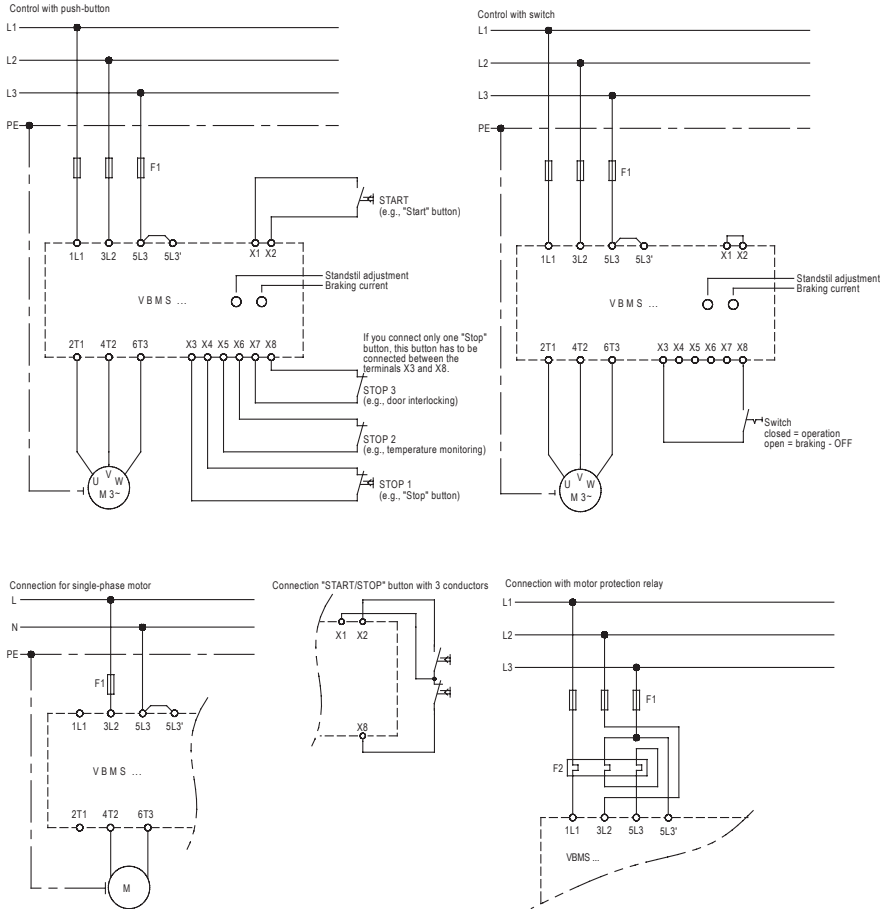

EMC

The limit values for emitted interference according to the applicable device standards do not rule out the possibility that the limit values according to the basic standard EN 61000-6-3:2007 are exceeded. If it is necessary to comply with the limit values of the basic standard EN 61000-6-3:2007, PETER electronic will offer appropriate solutions for the VBMS device series. In this case, please contact us. We point out that the creator of the plant / machine shall be responsible to ensure compliance with the EMC law.



www.peter-electronic.com

