

Ezi-IO[®]

Input/Output Module

- CC-Link IE TSN Based Digital I/O Module
- CC-Link IE TSN Authentication Class B
- Input Filter Function
- Simple and Easy Wiring

CC-Link IE TSN
DIO

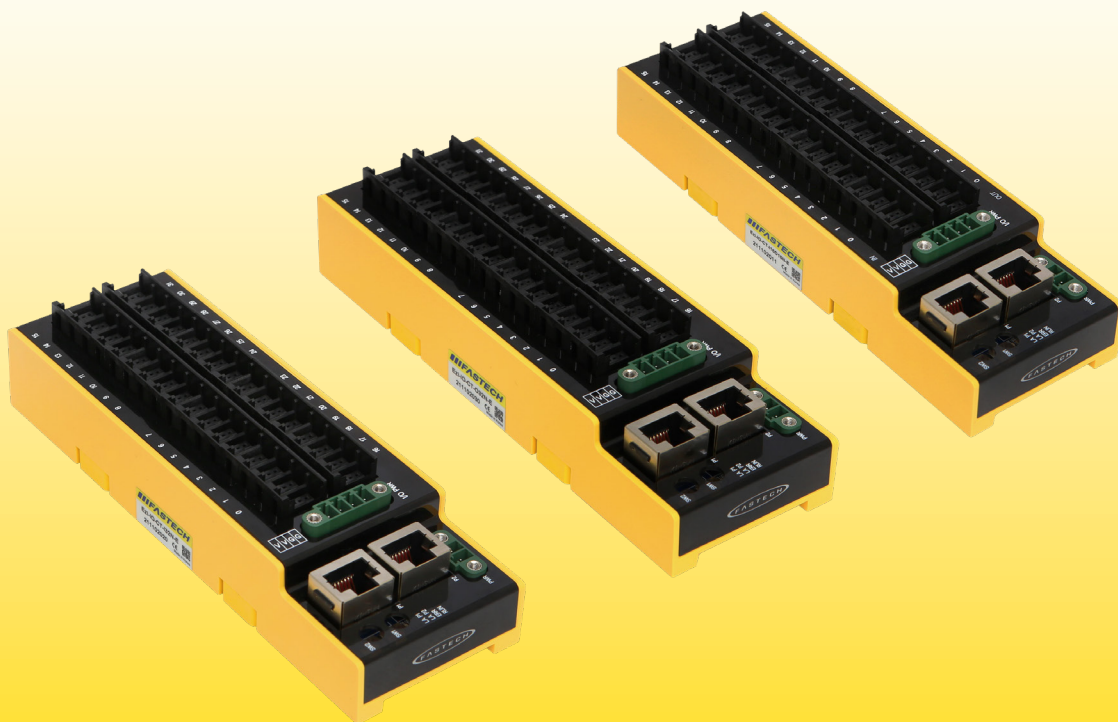

CE

FASTECH

Fast, Accurate, Smooth Motion

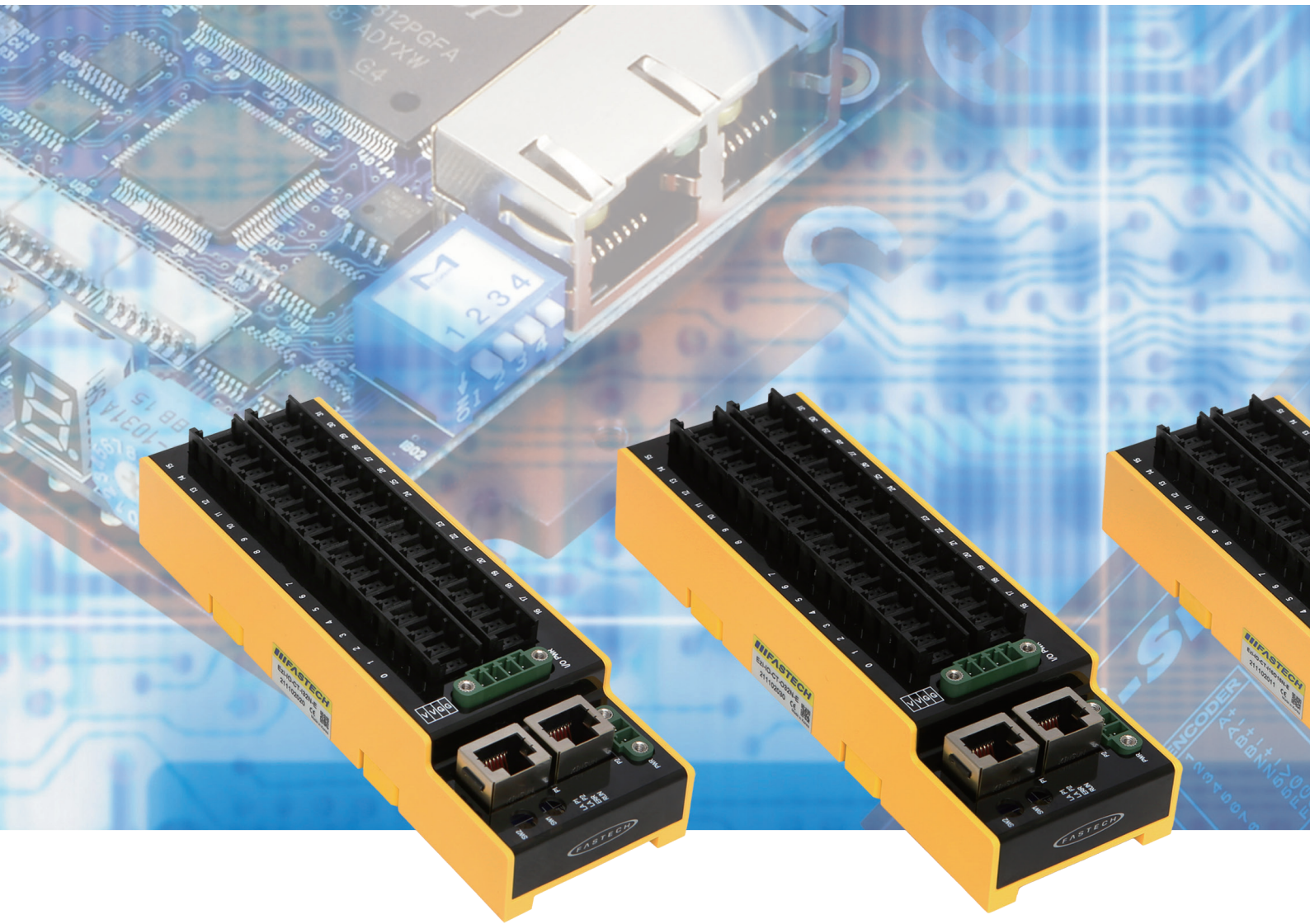

Fast, Accurate, Smooth Motion

Ezi-IO[®] CC-Link **IE TSN**
Input/Output Module **DIO**

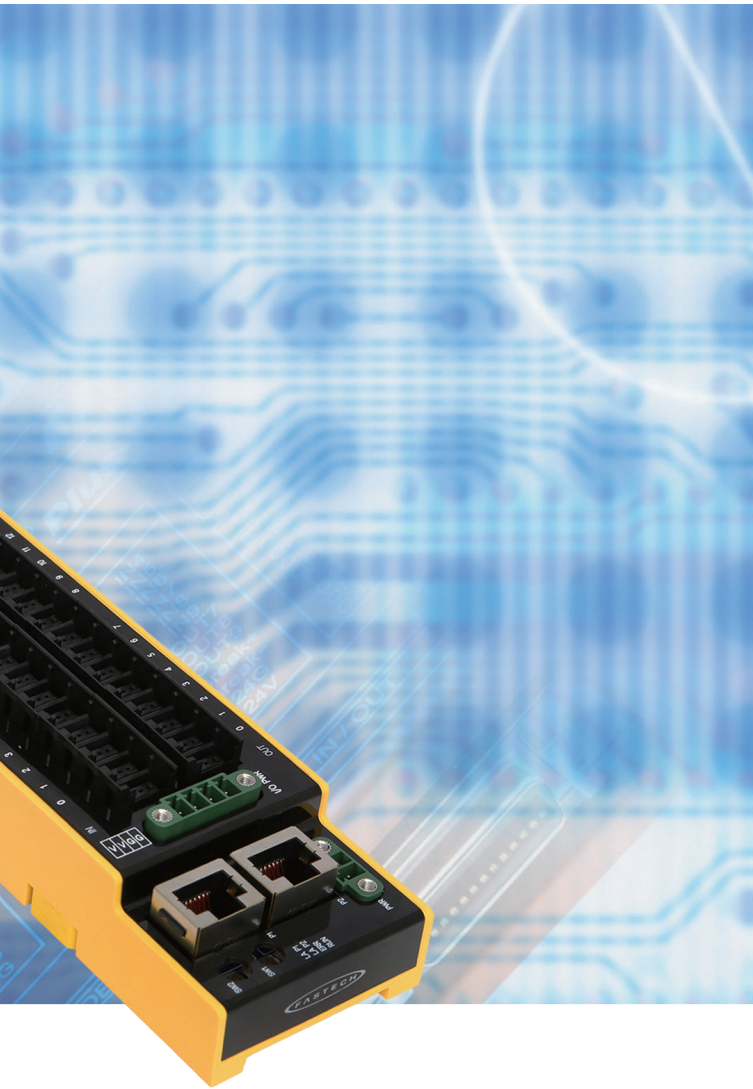

1 CC-Link IE TSN Based Digital I/O Module

Ezi-IO CC-Link IE TSN DIO is Digital I/O Module which supports CC-Link IE TSN, a fieldbus based on high speed Ethernet(1Gbps, Full-Duplex). Ezi-IO CC-Link IE TSN DIO is a remote device station connected to the CC-Link IE TSN system. It supports various topologies to configure the system flexibly.

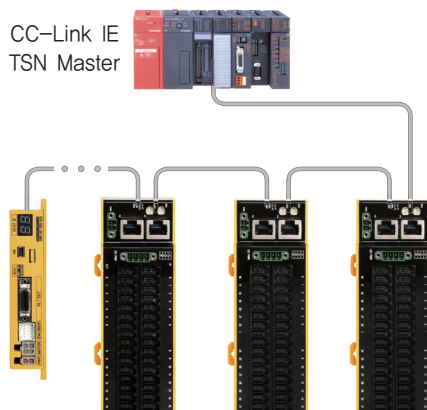

2 Simple and Easy Wiring

Ezi-IO CC-Link IE TSN DIO uses e-CON connectors. The e-CON connector is widely used in the sensor connector industry, and making the wiring much simpler and easier.

3 Various I/O Module Supported

Ezi-IO CC-Link IE TSN DIO provides 32CH DC input module, 32CH transistor output module, and 16CH DC input/8CH transistor output module.

4 Input Filter Function

The input module can prevent unstable operation of the input signal due to chattering or noise with the input filter function.

● Ezi-IO CC-Link IE TSN DIO Part Numbering

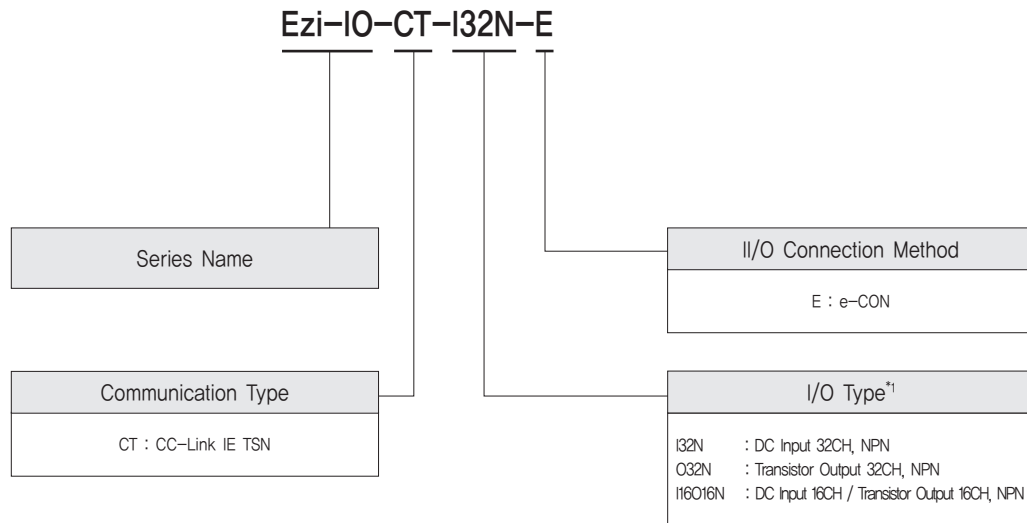

*1: NPN and PNP are classified as follows according to I/O type.

DC Input	NPN	Positive Common Type
	PNP	Negative Common Type
Transistor Output	NPN	Sink Type
	PNP	Source Type

● Ezi-IO CC-Link IE TSN DIO Part Number

Part Number	Remarks
Ezi-IO-CT-I32N-E	32CH e-CON Connector type
Ezi-IO-CT-O32N-E	
Ezi-IO-CT-I16O16N-E	

● Specifications of Module

Model		Ezi-IO-CT-I32N-E	Ezi-IO-CT-O32N-E	Ezi-IO-CT-I16O16N-E
Input Voltage		DC24V±10%		
Current Consumption		<ul style="list-style-type: none"> Control Power: Max, 150mA I/O Power: Max, 110mA (Except Load Current) 	<ul style="list-style-type: none"> Control Power: Max, 180mA I/O Power: Max, 70mA (Except Load Current) 	<ul style="list-style-type: none"> Control Power: Max, 170mA I/O Power: Max, 90mA (Except Load Current)
Operating Condition	Ambient Temperature	<ul style="list-style-type: none"> In Use : 0~50℃ In Storage: -20~70℃ 		
	Humidity	<ul style="list-style-type: none"> In Use : 35~85%RH (Non-Condensing) In Storage: 10~90%RH (Non-Condensing) 		
	Vib. Resist.	0,5g		
Function	Input	Number of Input Channels	32CH	16CH
		Rated Input Voltage	DC24V	DC24V
		Rated Input Current	5mA/CH	5mA/CH
		Isolation Method	Photocoupler Isolation	Photocoupler Isolation
		Common Method	16CH/COM	16CH/COM
		Input filter	Max, 40ms (Filter Resolution: 200μs)	Max, 40ms (Filter Resolution: 200μs)
		Off→On Response Time	10μs or lower	10μs or lower
	On→Off Response Time	70μs or lower	70μs or lower	
	Output	Number of Output Channels	32CH	16CH
		Rated Input Voltage	DC24V	DC24V
		Rated Input Current	0,5A/CH (3A/COM)	0,5A/CH (3A/COM)
		Isolation Method	Photocoupler Isolation	Photocoupler Isolation
		Common Method	16CH/COM	16CH/COM
		Off→On Response Time	4μs or lower	4μs or lower
On→Off Response Time		190μs or lower	190μs or lower	
LED Display		<ul style="list-style-type: none"> Control Power Status (PWR) Module Status (RUN) Operation Error (ERR) CC-Link IE TSN Connection (LA P1, LA P2) I/O Status (0~31) 		<ul style="list-style-type: none"> Control Power Status (PWR) Module Status (RUN) Operation Error (ERR) CC-Link IE TSN Status (LA P1, LA P2) I/O Status (0~15/0~15)
CC-Link IE TSN	Station Type	Remote Device Station		
	Authentication Class	Class B		
	Communication Speed	1 Gbps		
	Bus Interface	2×RJ45 Connector		
	Cable	STP (Shielded Twisted Pair) Cable, Category 5e or higher / Max, 100m		

● Dimensions of Module [mm]

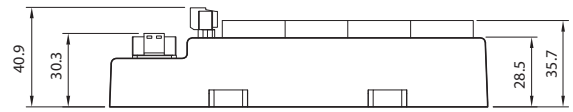
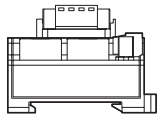
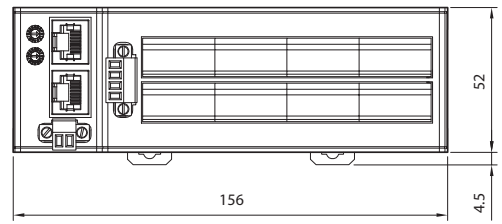
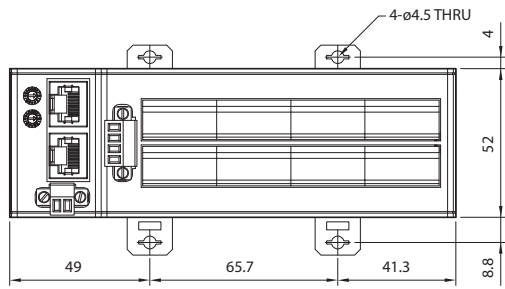

* Install the product on a din rail with a width of 35 mm.

● Settings and Operation

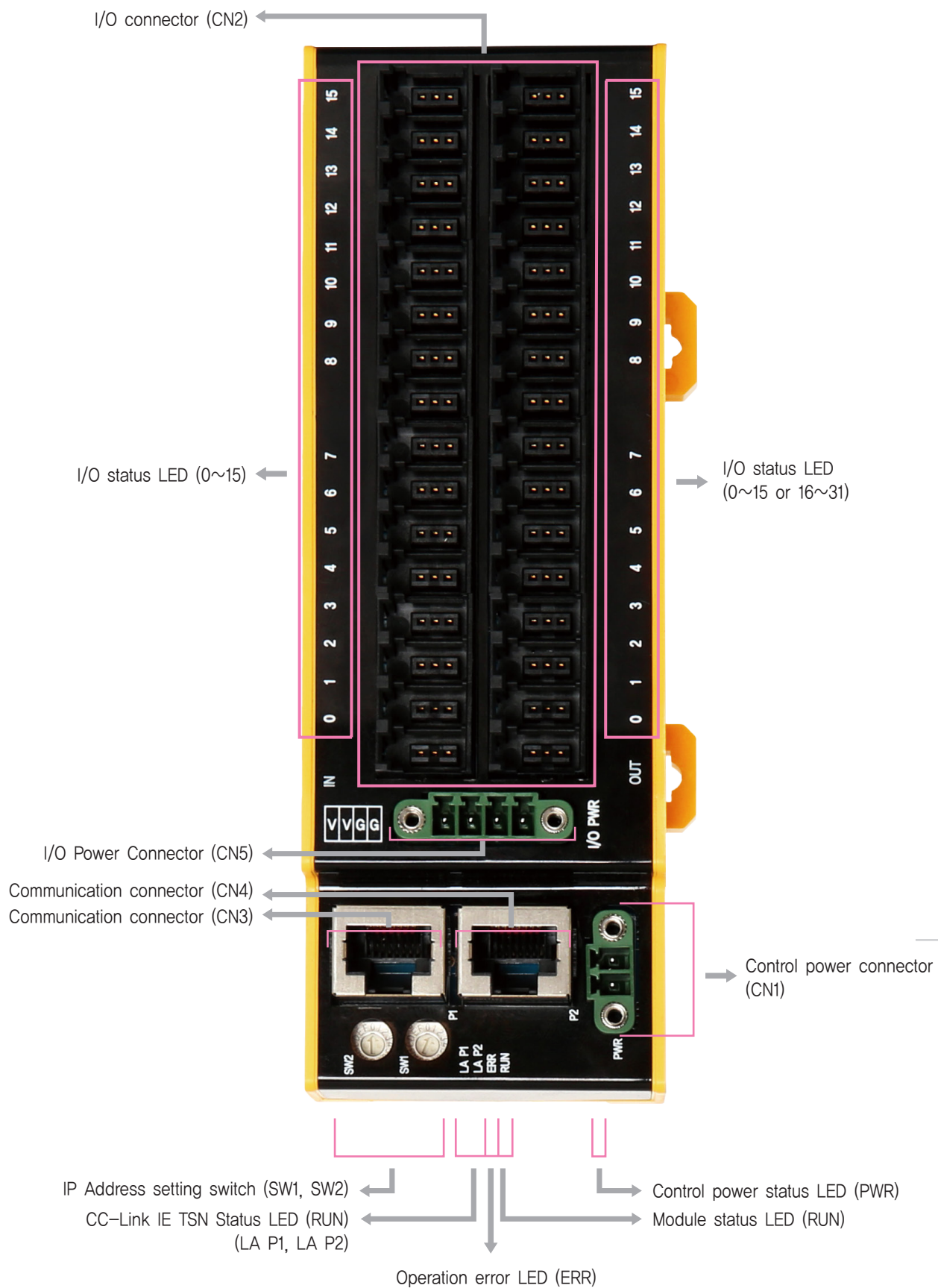

1. IP Address Setting Switch (SW1, SW2)

These switches set the 4th octet of IP address for CC-Link IE TSN communication.

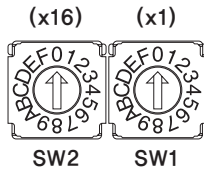

e.g.) In case of SW2 : 5 and SW1 :
 $(5 \times 16) + (7 \times 1) = 87$
 IP is to be set as 192.168.3.87

2. Status LED

• Control Power Status LED

Name	Color	Status	Description
PWR	Red	OFF	Power is OFF
		ON	Power is ON

• Module Status LED

Name	Color	Status	Description
RUN	Green	OFF	Initialized or Power is OFF
		ON	Normal Operation

• Operation Error LED

Name	Color	Status	Description
ERR	Red	OFF	No Error or Power is OFF
		ON	Data Link Error

• CC-Link IE TSN Status LED

Name	Color	Status	Description
LA P1 / LA P2	Green	OFF	Link not Established
		ON	Link Established

• I/O Status LED

Name*	Color	Status	Description
0~31 0~15 / 0~15	Green	OFF	Input Module : Input is OFF Output Module : Output is OFF
		ON	Input Module : Input is ON Output Module : Output is ON

* For Ezi-IO-CT-I16O16N-E module, the name is written as 0~15 / 0~15.

3. Control Power Connector (CN1)

No.	Function	I/O
1	DC24V	Input
2	GND	Input

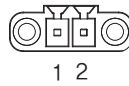

4. I/O Connector (CN2)

No.	Function	I/O
1	EXT_DC24V	Input
2	SIGNAL	I/O
3	EXT_GND	Input

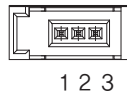

5. Communication Connector (CN3, CN4)

No.	Function
1	TD+
2	TD-
3	RD+
4	----
5	----
6	RD-
7	----
8	----
Connector Hood	F.GND

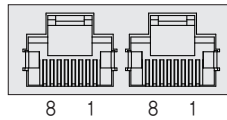

6. I/O Power Connector (CN5)

No.	Function	I/O
1	EXT_DC24V	Input
2	EXT_DC24V	Input
3	EXT_GND	Input
4	EXT_GND	Input

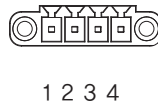

System Configuration

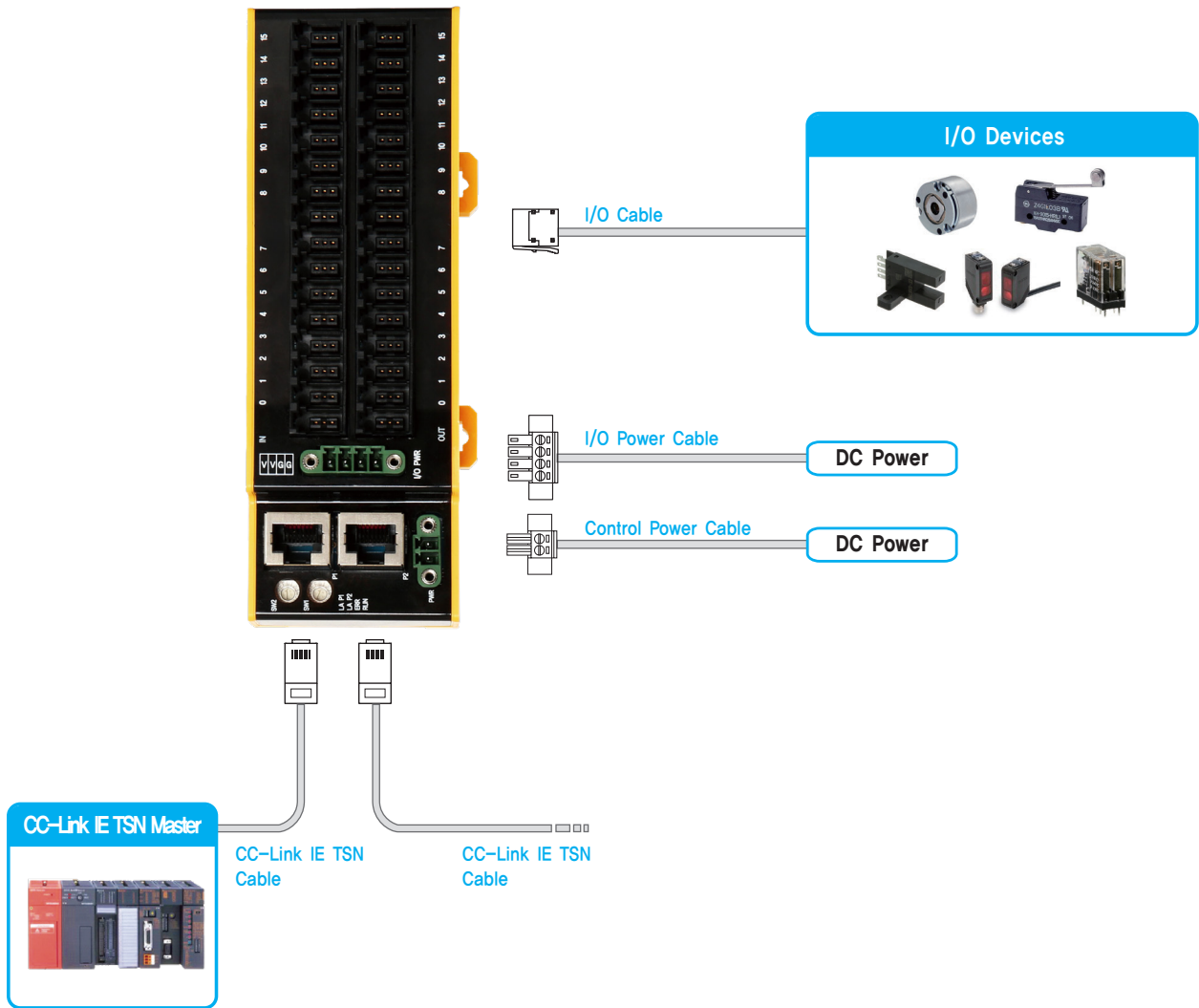

FASTECH Ezi-I/O CC-Link IE TSN DIO

1. Accessories

• Connectors

Purpose	Item	Part Number	Manufacturer
Control Power (CN1)	Terminal Block	MC421-38102	DECA
I/O Power (CN5)	Terminal Block	MC421-38104	DECA
Signal (CN2)	e-CON Plug Connector	CNE-P03-YW	Autonics

※ The connectors above are supplied with the product. If you are using other parts, please make sure they meet the specifications.

2. Options

• CC-Link IE TSN Cable

Purpose	Part Number	Length [m]	Remarks
CC-Link IE TSN Connection (CN3, CN4)	CGNR-EC-001F	1	· STP(Shielded Twisted Pair) Cable · Category 5e or higher · Maximum Length: 100m · Normal Cable
	CGNR-EC-002F	2	
	CGNR-EC-003F	3	
	CGNR-EC-005F	5	

※ If you need cables with length(in units of 1m) not listed on the table or robot cables, please contact FASTECH for more information.

External Wiring Diagram

1 Ezi-IO-CT-I32N-E (NPN)

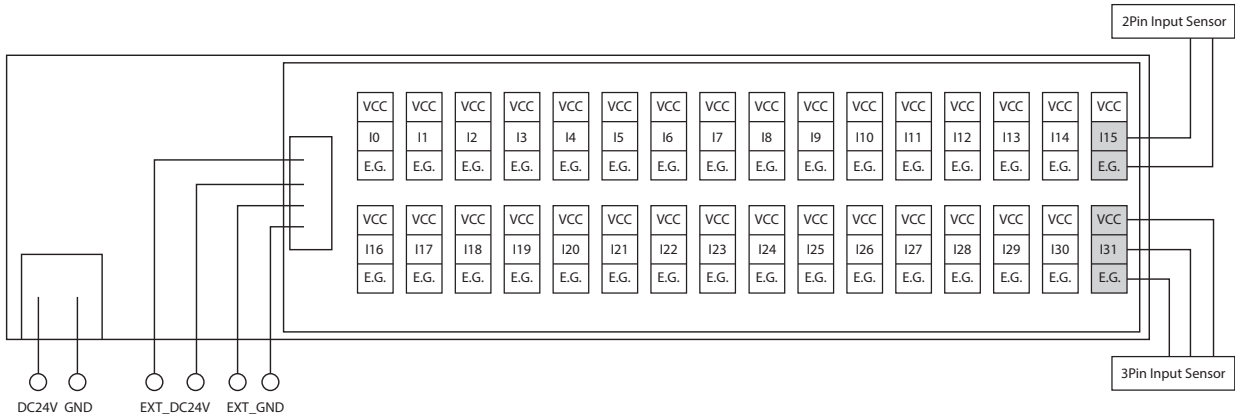

2 Ezi-IO-CT-O32N-E (NPN)

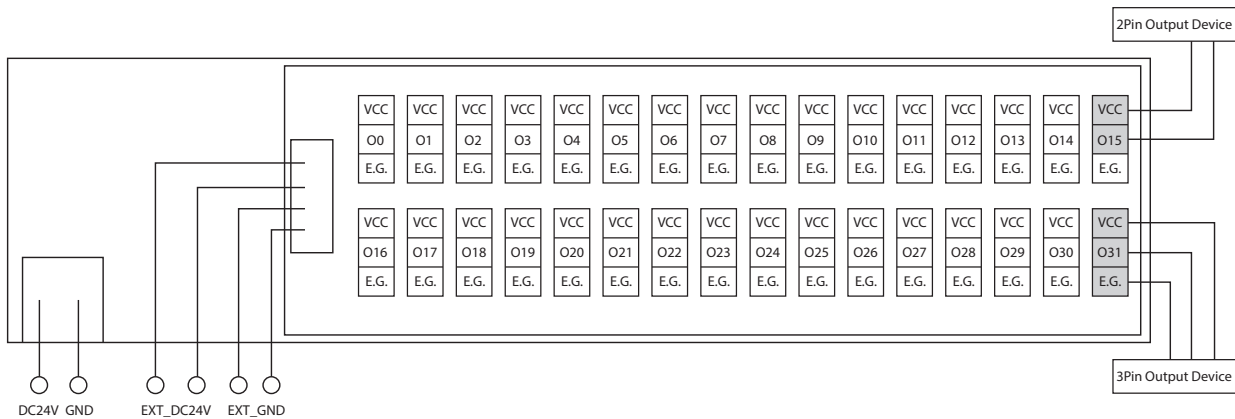

3 Ezi-IO-CT-I16O16N-E (NPN)

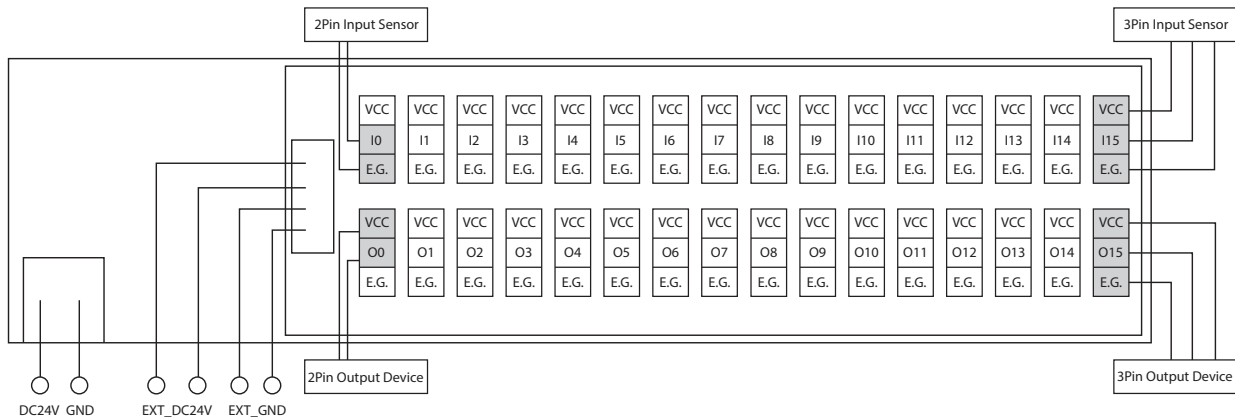

- ※ VCC and E.G are supplied from I/O Power Connector(CN5).
- ※ e.g.)
 - 2Pin Input Sensor : Limit Sensor, etc.
 - 3Pin Input Sensor : Position Sensor, Photo Sensor, Proximity Sensor, etc.
 - 2Pin Output Device : Brake, Solenoid, Photocoupler, etc.



Fast, Accurate, Smooth Motion

FASTECH Co., Ltd.

Rm#1202, 401-dong, Bucheon Techno-Park,
655, Pyeongcheon-ro, Bucheon-si Gyeonggi-do,
Republic of Korea (Postal Code: 14502)
TEL : +82-32-234-6317 FAX : +82-32-234-6302
E-mail : sales@fastech-motions.com
Homepage : www.fastech-motions.com